

10/100BASE-T Integrated Connector Modules

Features:

- Single port RJ-45 connector with integrated 10/100 magnetics
- Complies with IEEE standards and all 10/100 Ethernet specifications including 350uH min with 8mA DC bias
- Operating temperature 0°C to 70°C
- Minimum interwinding breakdown voltage of 1500Vrms

Electrical Specifications @ 25°C

Isolation: 1500Vrms(UTP Side to Chip Side)

OCL: 350uH Minimum @ 100KHz 100mV with 8mA DC

Insertion Loss : 100KHz-100MHz: -1.1dB max

Return Loss: 1MHz-30MHz: -18dB min

30MHz-60MHz: -15dB min

60MHz-80MHz: -12dB min

Common to Differential Mode Rejection : 100KHz-100MHz: -40dB min

Common to Common Mode Rejection : 100KHz-100MHz : -30dB min

Crosstalk: 100Kz-100MHz : -35dB min

Schematics:

YL2J201A:

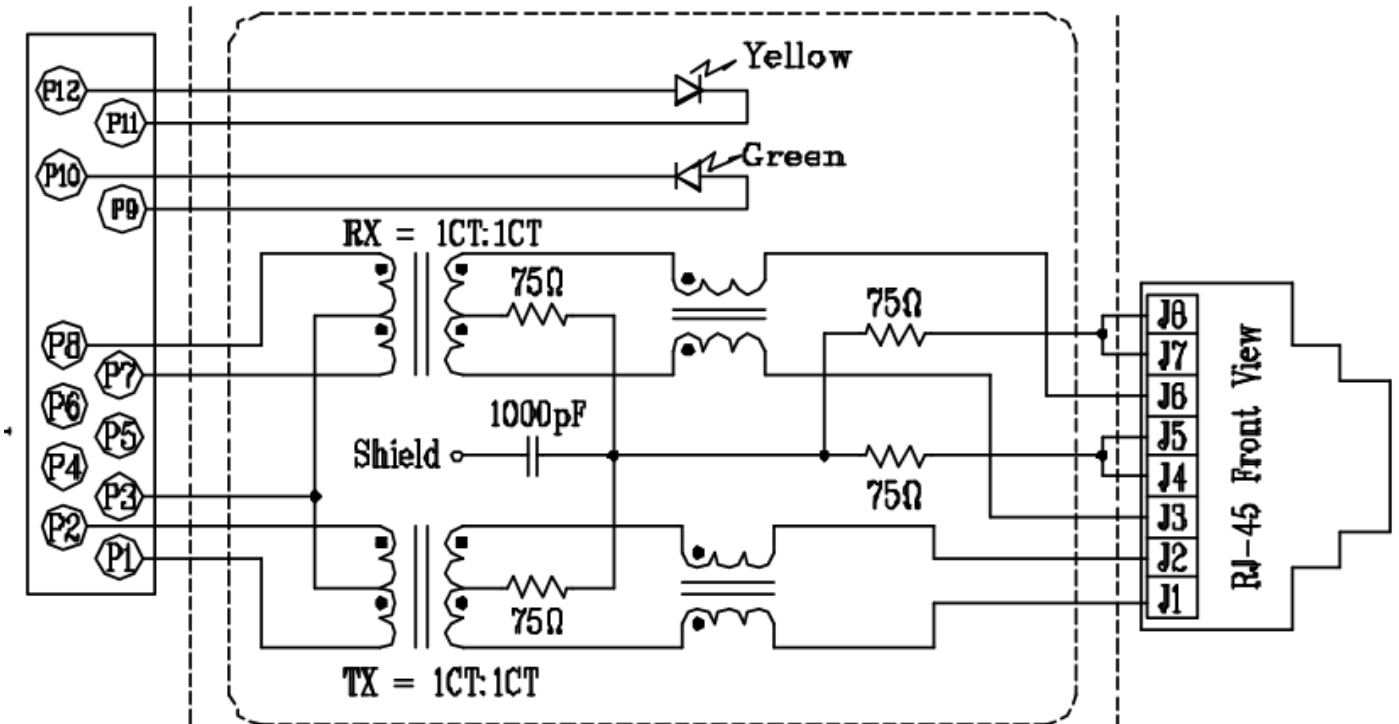

Mechanical

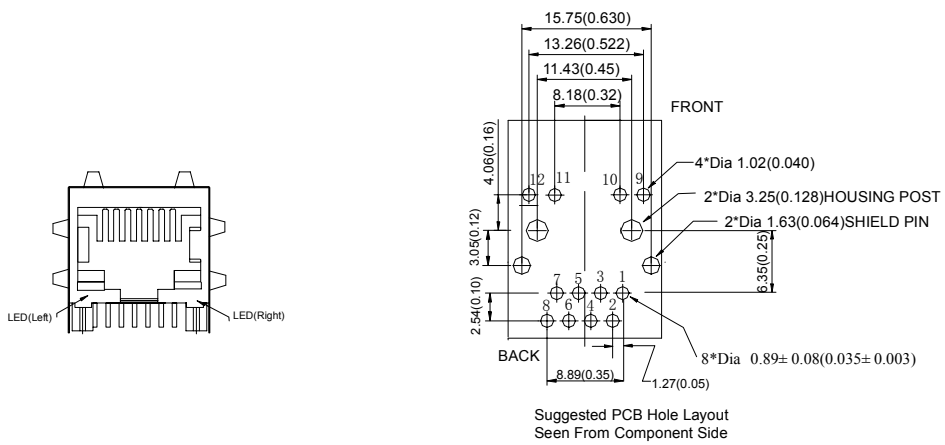
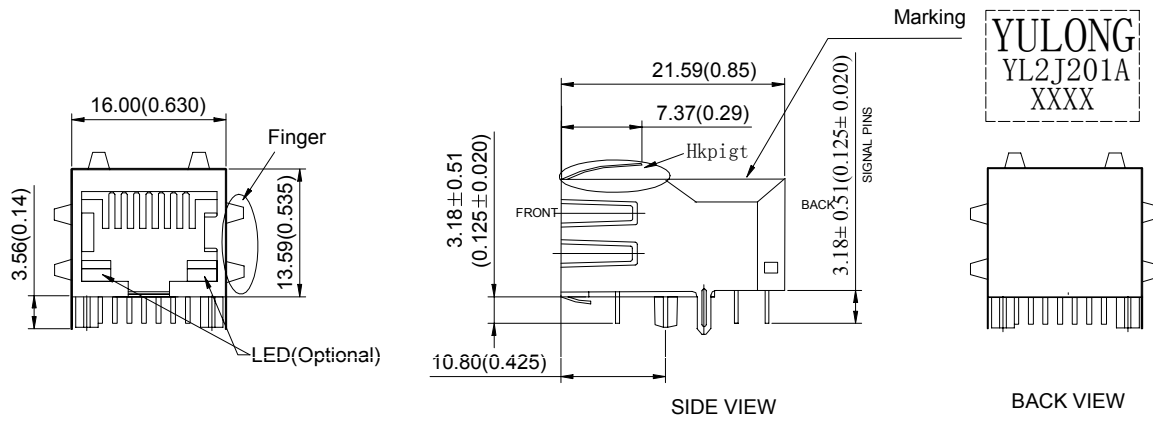

NOTE:Dimensions:mm unless otherwise specified all tolerances are ±0.25