

10GBASE-T MAGNETICS MODULES

10GYT002

Features:

- Compliant with IEEE 802.3 standard
- Qualified with top 10Gig PHY Manufacturer
- RoHS peak reflow temperature rating: 245°C
- Operating temperature -40°C to +85°C
- Low profile package for PCI Express
- Minimum interwinding breakdown voltage of 1500Vrms

Electrical Specifications @ 25°C

Insertion loss: 100 KHz -3.0 dB MAX
 1-500 MHz -1.0 dB MAX

Return Loss:

(Z OUT = 100 OHM ± 1%)

1 MHz-40 MHz -18 dB MIN
 40-500 MHz $-17+10*\text{LOG}_{10}(f/40)$ dB MIN

Crosstalk : 1-100 MHz -40 dB MIN
 100-500 MHz -30 dB MIN

Common mode rejection ratio: 1-100 MHz -35 dB MIN
 100-300 MHz -30 dB MIN
 300-500 MHz -25 dB MIN

Common to differential mode rejection(CDMR):

1-125 MHz -30 dB MIN
 125-500 MHz -22 dB MIN

Note: f is frequency in MH

Schematics

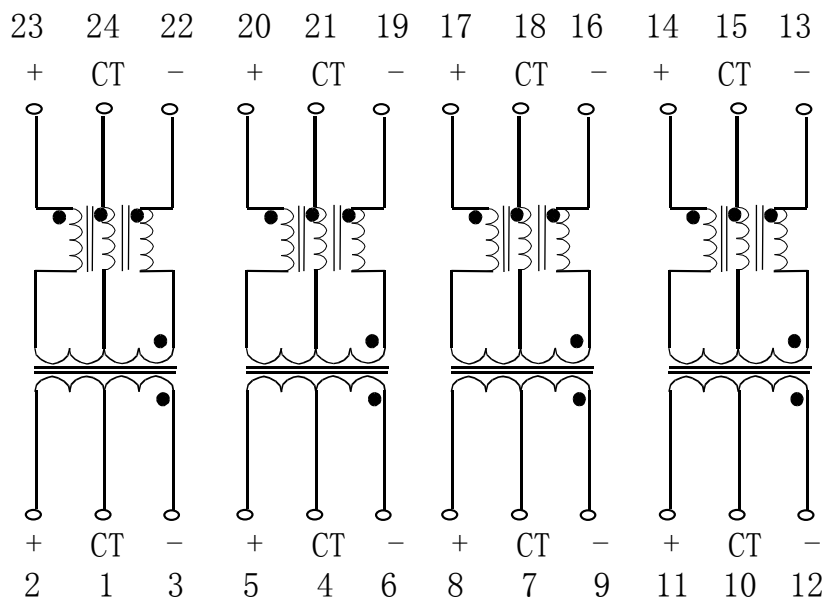

Mechanicals

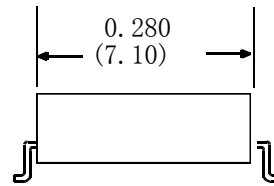
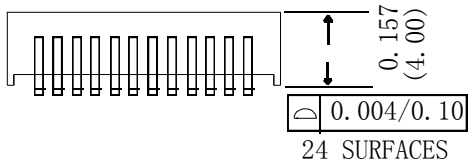
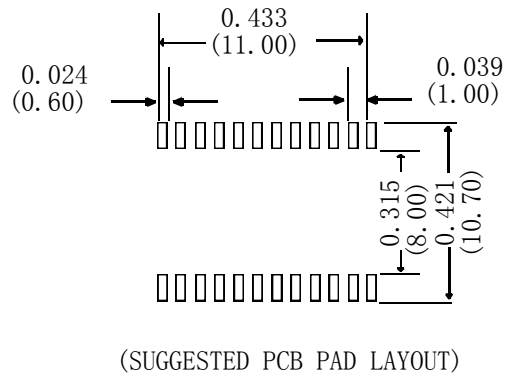
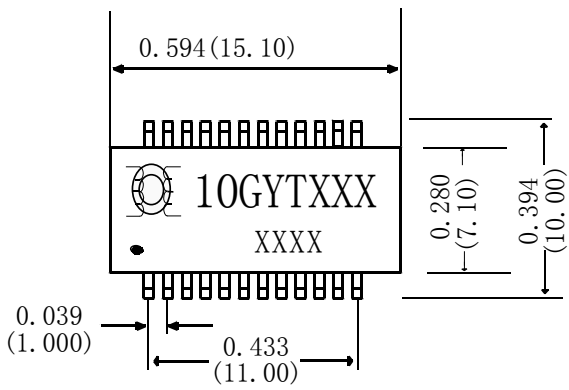

NOTE: Dimensions: inches/(mm) unless otherwise specified all tolerances are $\pm 0.010(0.25)$