

10/100BASE-TX VOIP Magnetics Modules with PoE capability

Features:

- Compatible With Various 10/100TX Transceiver Requiring 1:1 Transmit and 1:1 Receive Turn Ratio
- all IEEE 802.3 and ANSI X3.263 standard including 350 uH OCL with 8 mA bias
- 10/100BASE-TX VOIP Magnetics Modules with PoE capability
- Minimum interwinding breakdown voltage of 1500Vrms

Electrical Specifications @ 25°C

Part Number	Insertion Loss (dB Max)	ReturnLoss (dB min)			Crosstalk (dB min)		
		0.1MHz to 100MHz	0.1MHz to 30MHz	30MHz to 60MHz	60MHz to 80MHz	30MHz	60MHz
YP18-2107S	-1.4	-16	-14	-12	-40	-35	-30

Schematics

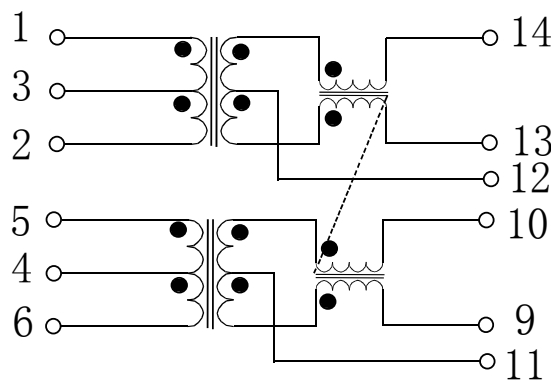

Mechanicals

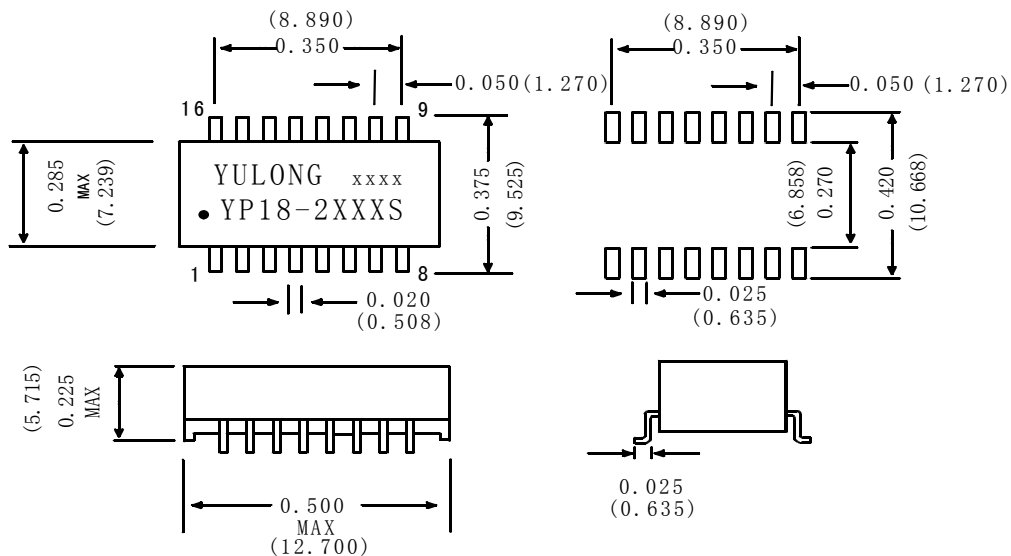

NOTE:Dimensions:inches unless otherwise specified all tolerances are ± 0.010